



وكالة هيئة الأمم المتحدة  
دائرة التربية والتعليم  
مركز التطوير التربوي

أسئلة للتدريب على امتحان  
نهاية الفصل الدراسي الثاني  
في مادة العلوم

للسف السادس الأساسي

2008 / 2007

-1 -

- - -

-2 -

- - -

-3 -

48 - 24 - 18 - 15 -

-4 -

- - -

-5 -

- - -

-6 -

- - -

-7 -

(7 - )

- - -

-8 -

- - -

-9 -

- - -

-10 -

-: Co2



3 - 2 -

(3+2) - 1 -

-11 -

60

50 - 60 - 40 - 10 -

-12 -

2 - 3 -

4	3	2	1	
65	60	40	10	

1 - 4 -

-13 -

- - -

-14 -

- - -

-15

-:

4	3	2	1	
8	6	4	2	

1 -

4 -

2 -

3 -

-16

-:

-

-

-

-

-17

-:

-

-

-

-

-18

-:

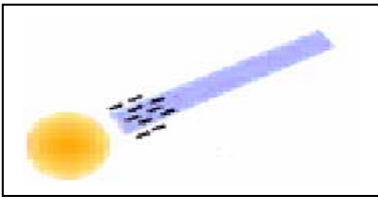

( )

( )

( )

( )

-

-

-

-

-19

-:



(2 1)

(3 2)

(3 1)

(3 2 1)

-

-

-

-

-20

-:

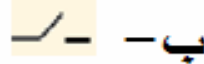
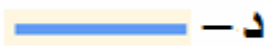

-

-21

-:

-

-

-

-

-22

-:

-

-

-23

-:

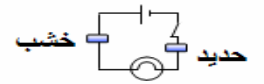
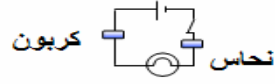
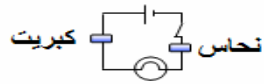
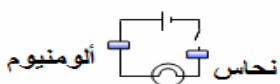

د -

ج -

ب -

أ -

-

-24

-:

-

-

-

-

-25

-:

-

-

-

-

-1

-2

-3

-4

-5

-6

-7

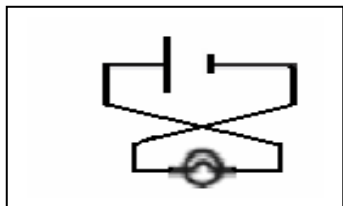

( -

-1

-2

-3

%50

-4

-5

-6

-:

/

\*\*\*

- .1
- .2
- .3
- .4
- .5
- .6

-:

/

\*\*\*

/

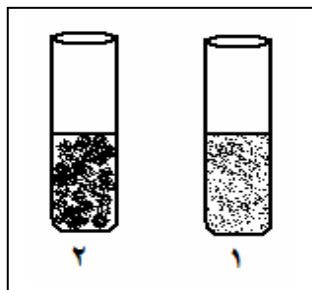

-----

-----

-----

/



\*\*

\*\*

\*\*

\*\*

-:

/

\*\*\*

-:

-1

-

-

-

-

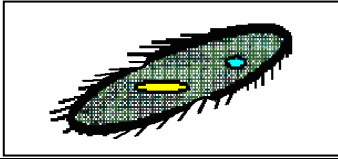

-:

-2

-

-

-

-



-:

-3

-

-

-

-

-:

-4

-

-

-

-

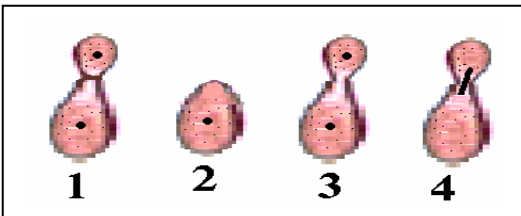

:

-5

2 1 3 4 -

1 3 4 2 -

1

2

3

4

4 3 2 1 -

2 1 4 3 -

20

-6

32 -

64 -

8 -

:

16 -

-:

-7

-

-

-

-

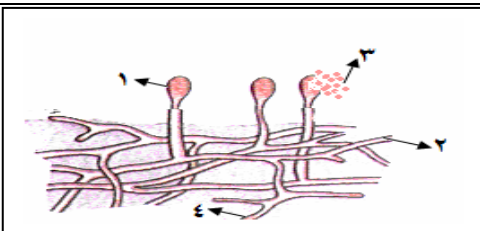

-:

-8

3 -

1 -

2 -

4 -

-:

-9

-

-

-

-

-:

-10

-

-

-

-

-:

-11

-

-

-

-:

36

-12

12 -

36 -

18 -

24 -

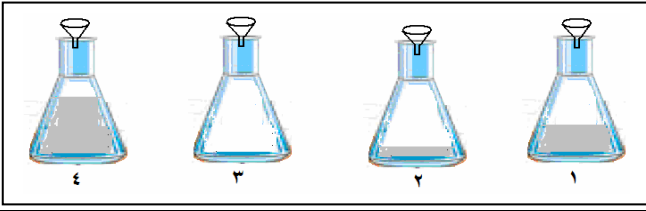

-:

2 -

1 -

4 -

3 -

-:

-14

-

-

-

-

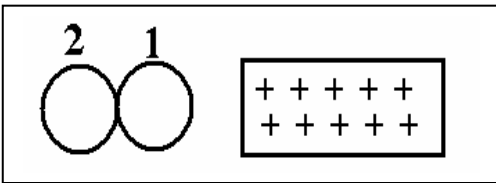

-: ( 2 )

-15

-

-

-

-

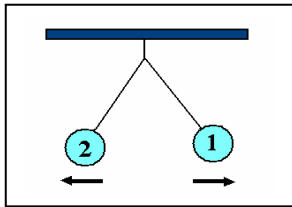

-:

-16

(2)

(1) -

(2)

(1) -

(2)

(1) -

(1)

(2) -

-:

-17

-

-

-

-

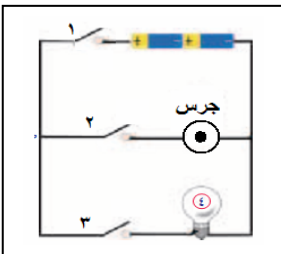

-:

-18

(2)

-

(1)

-

(2)

(1)

-

(2)

( )

-

-:

-19

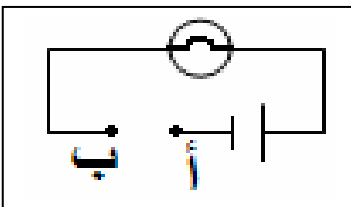

-

-

-

-



-:

-20

-

-

-

-

-:

/

\*\*

. \_\_\_\_\_

.1

. \_\_\_\_\_

.2

. \_\_\_\_\_

.3

. \_\_\_\_\_

.4

. \_\_\_\_\_

.5

. \_\_\_\_\_

.6

. \_\_\_\_\_

.7

. \_\_\_\_\_

.8

. \_\_\_\_\_

.9

-:

/

\*\*

. ----- -1

. ----- -2

. ----- -3

. ----- -4

. ----- -5

:

( - /

\*\*\*

. ----- : -1

. ----- : -2

. ----- : -3

. ----- : -4

. ----- : -5

-:

/

\*\*\*

.1

----- :

.2

----- :

.3

----- :

.4

----- :

.5

----- :

.6

----- :

-:

/

\*\*\*

( -

-----

(

)

( -

-----  
-----

3

( -

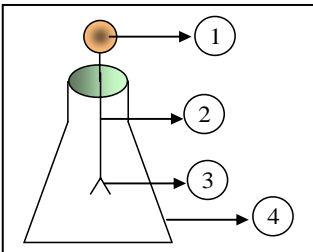

-:

( -

1

-----

2

-----

3

-----

4

-----

( -

( ----- )

\*\*

\*\*

\*\*

\*\*

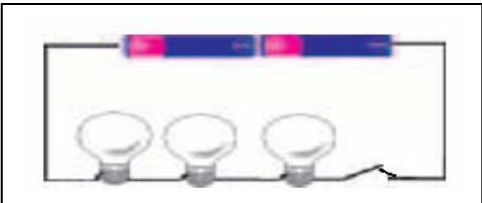
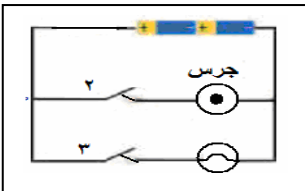
( ) -	-:	-	-	-1
-	-:	-	-	-2
-	-:	-	-	-3
	-:	-	-	-4
( ) -	-:	-	-	-5
-:	-	-	-	-6
-	-:	-	-	-7
-	-:	-	-	-8
-	-:	-	-	-9
-	:	-	-	-10
صوف +++ - - - بلاستيك ++ ++	صوف - + + +++ بلاستيك + + + +	صوف + + + + + بلاستيك + + + +	صوف - - - +++ بلاستيك +++	-11
	-:	-	-	-12
	-:	-	-	-13

-:

-14

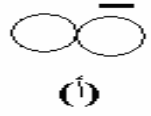
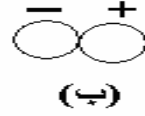
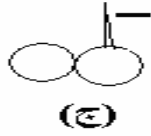
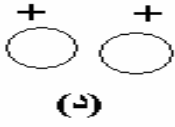

-:

-15

-

-

-

-

-:

/

\*\*

----- .1

----- .2

-:

/

\*\*

-1

----- :

-2

----- :

-3

----- :

-4

----- :

-5

----- :

-6

----- :

-7

----- :

-8

----- :

-9

----- :

-10

----- :

-11

----- :

-12

----- :

-13

----- :

-1

-----

35

4 -2

-----

-3

-----

-----

-4

-----

-----

-----

-: -5

(( - ))

-----

-----

( -

-----

-----

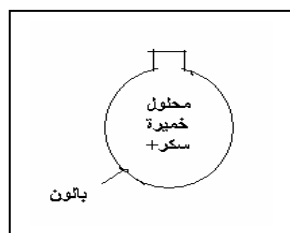

20

( -

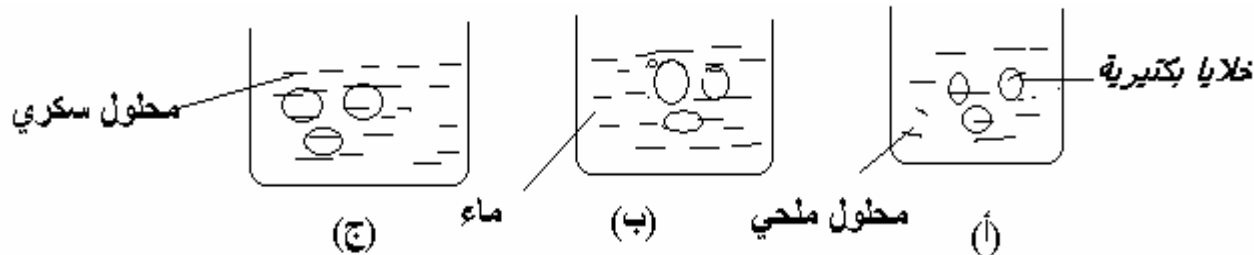

-----

-----/

(-

-:



-----:

-----:

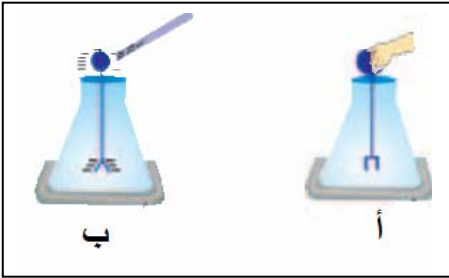

-:

(-

-----:

-----:

-----:

-----:

3 1000

(-



ج- تربة غرينية



ب- تربة رملية



أ- تربة طينية

-----

-----:

(-

-

-

(-

-

-

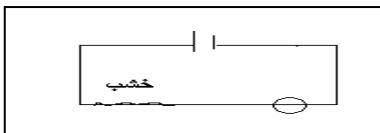

-:

(-

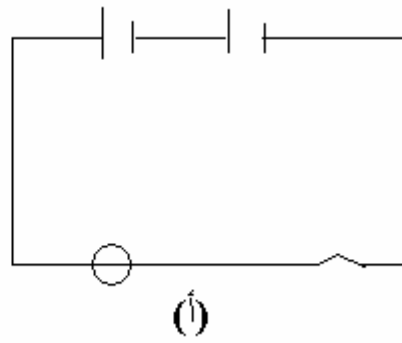
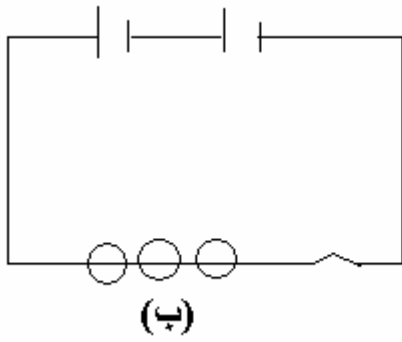

-----  
 -----  
 ----- ( )

:

(-

-

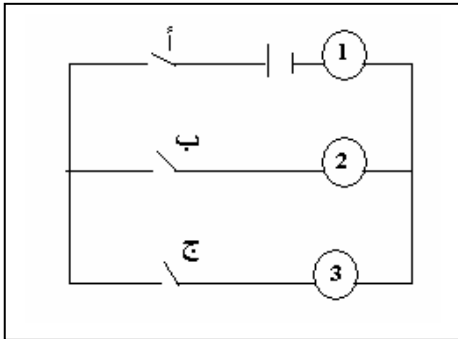

-:

(-

( )

-1

-----  
 ( ) ( ) -2  
 -----

-:

/

\*\*\*

-----  
 -----: .1  
 -----: .2  
 -----: .3  
 -----:

\*\*

\*\*

\*\*

\*\*